

BLACK HINGED AND BLIND COVERS

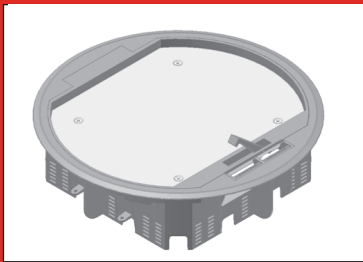

RAL 9011



RAL 7011: steel grey



RAL 9011: graphite black

HINGED COVERS - AND BLIND COVERS

Due to their success and the increasing demand, the RAL 9011 (graphite black) finish has now been included in the range.

Our product references will be specified as follows:

KDRV 11*304	becomes	KDRV 6*304 RAL 9011
BDRV 11*304	becomes	BDRV 11*304 RAL 9011
BDR 5*257	becomes	BDR 5*257 RAL 9011
BDV 5*257	becomes	BDV 5*257 RAL 9011
KDR 5*257	becomes	KDR 5*257 RAL 9011
KDV 5*257	becomes	KDV 5*257 RAL 9011
KDVV 5*257	becomes	KDVV 5*257 RAL 9011
KDRV 5*257	becomes	KDRV 5*257 RAL 9011

The references of our grey versions will end in RAL 7011

e.g.: KDRV 5*257 RAL 7011

Availability: stock



For further info: export@vergokan.com

WATERPROOF COVERS

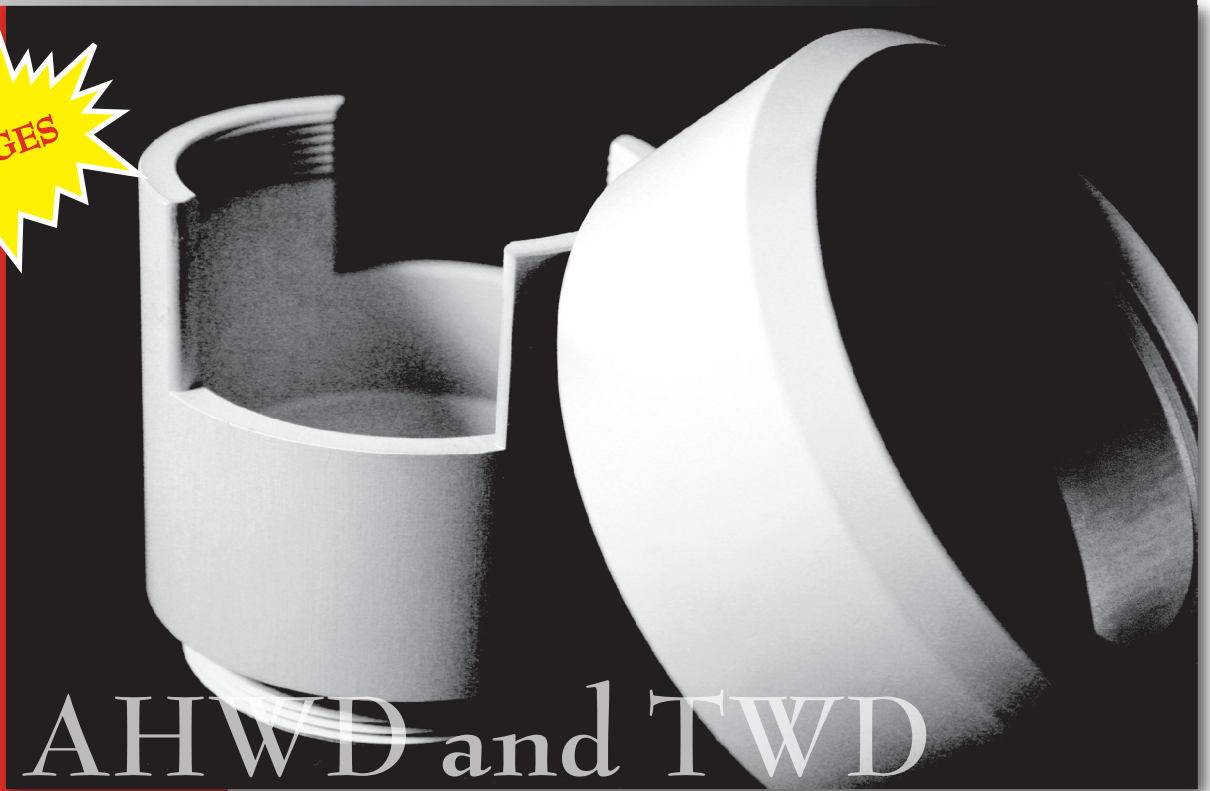

AHWD and TWD



AHWD: cover housing



TWD: tube

KDVWD and ITKVWD



Both waterproof covers will be supplied in future without tube and cover housing, which cuts the price. Both the TWD tube and the cover housing AHWD are in stock and can always be ordered separately. The tube and cover housing protrude 65 mm above the level of the finish.

Material

Anodised aluminium

Availability: stock

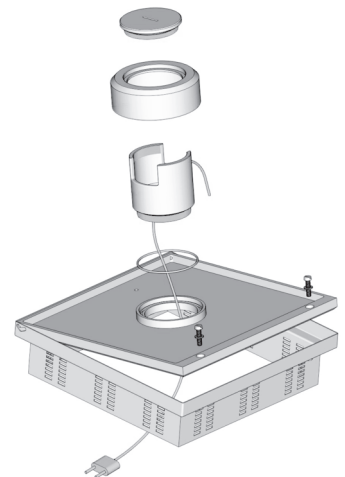

For further info: export@vergokan.com

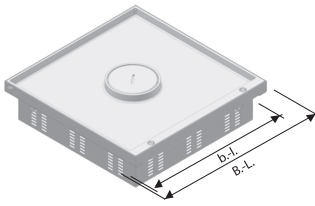
KDVWD

Hinged cover tile floor

B.-L.	b.-l.	art.-réf.
258mm	230mm	KDVWD 12*257



v



1,58

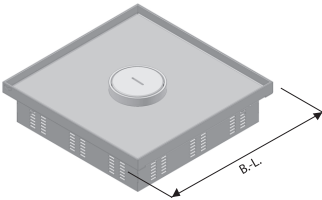

1

ITKVWD

Tile frame

B.-L.	art.-réf.
258mm	ITKVWD 13*257



v



1,37



1

TWD

Tube

art.-réf.

TWD



v



0,18

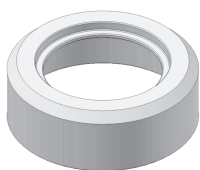

1

AHWD

cover housing

art.-réf.

AHWD



v



0,15



1

ROUND HINGED COVERS

CHANGES



KDR and KDRV

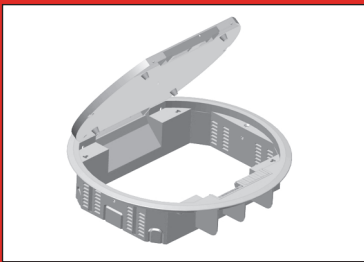

KDR and KDRV

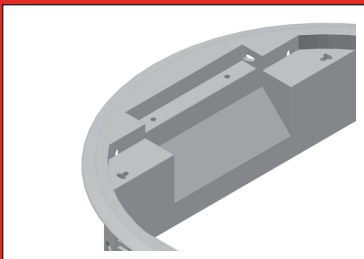

KDR 5*257 and KDRV 5*257

With the evolution of modern data cabling and to offer better guarantees of high-speed data transmission, it was decided to adapt the cable outlet of our little brother. Besides the change of the cable outlet a few months ago, we are now also looking at a solution so that the cables are distorted as little as possible when they are connected in our hinged covers.

Material
Polypropylene

Availability: stock



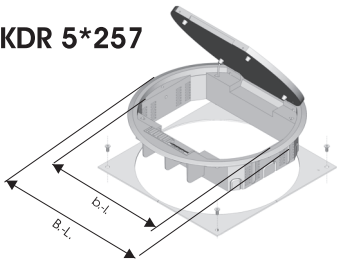

For further info: export@vergokan.com

KDR 5*257





Hinged cover, round

B.-L.	b.-l.	art.-réf.			
280mm	257mm	KDR 5*257 RAL 7011	v	1,46	6
280mm	257mm	KDR 5*257 RAL 9011	v	1,46	6

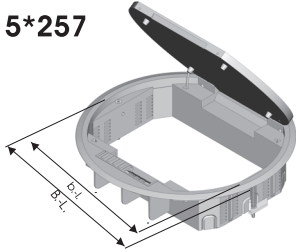
KDRV 5*257



Hinged cover, round, raised floor

B.-L.	b.-l.	art.-réf.			
280mm	257mm	KDRV 5*257 RAL 7011	v	1,46	6
280mm	257mm	KDRV 5*257 RAL 9011	v	1,46	6

FILLING FRAME for KDRV 6*304

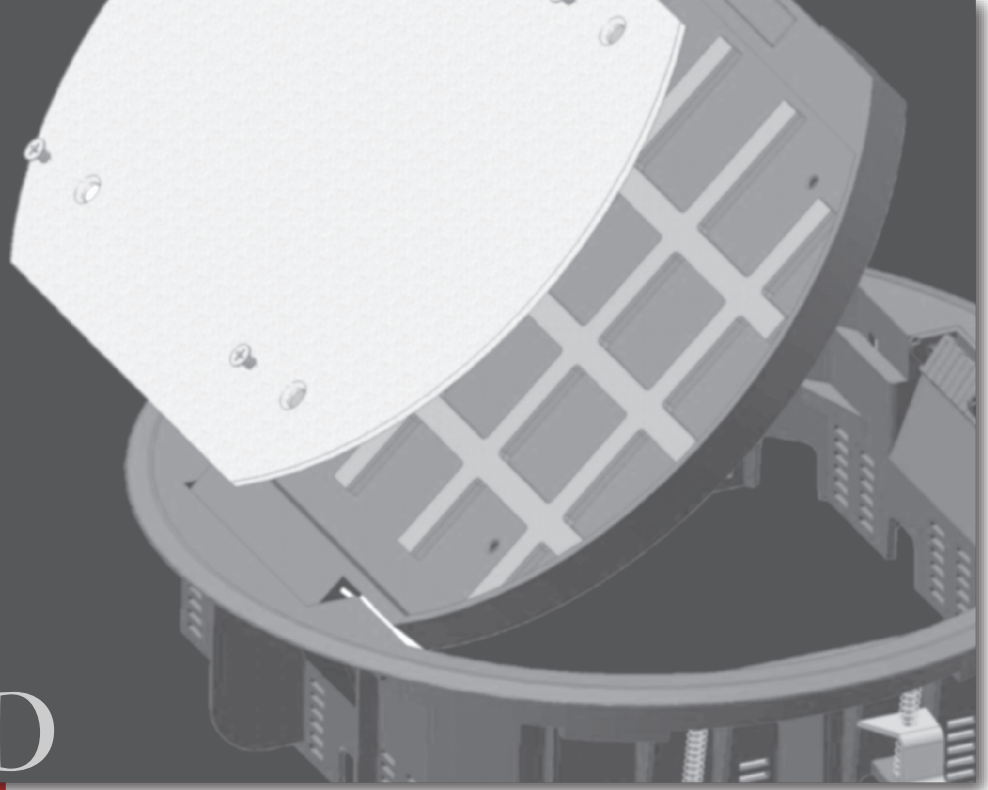

RKD

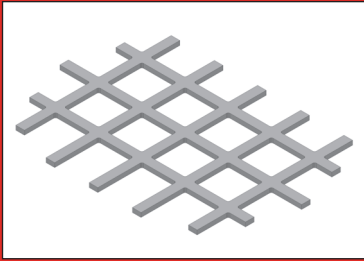

RKD: filling frame

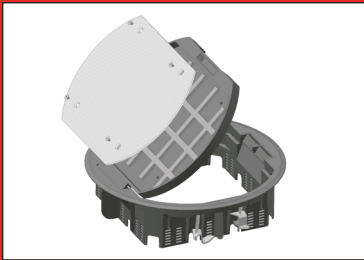

Filling frame RKD for hinged cover KDRV 6*304

By fitting the filling frame under the metal plate, the depth of the cut-out can be levelled to suit the flooring. Hinged cover KDRV 6*304 is supplied as standard with a filling frame of 5mm (RKD 5*304) which means that the standard depth of the cut-out of the hinged cover is 6mm.

On request :

From 200 pcs upward, the hinged cover is available with a filling frame of 3mm (RKD 3*304). Depth of cut-out of the cover 8mm.

When removing the filling frame a depth of cut-out of the hinged cover of 11mm is obtained.

Material

Polypropylene

Availability: stock

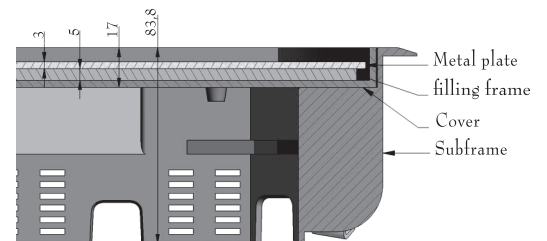

For further info: export@vergokan.com

RKD

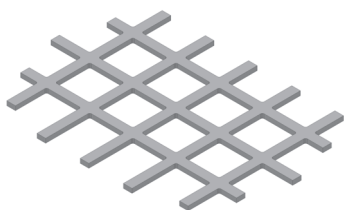

Filling frame for KDRV 304

dikte	art.-réf.			
3,00mm	RKD 3*304	v	0,05	1
5,00mm	RKD 5*304	v	0,09	1

FLOOR BOX for HEAVY LOADS

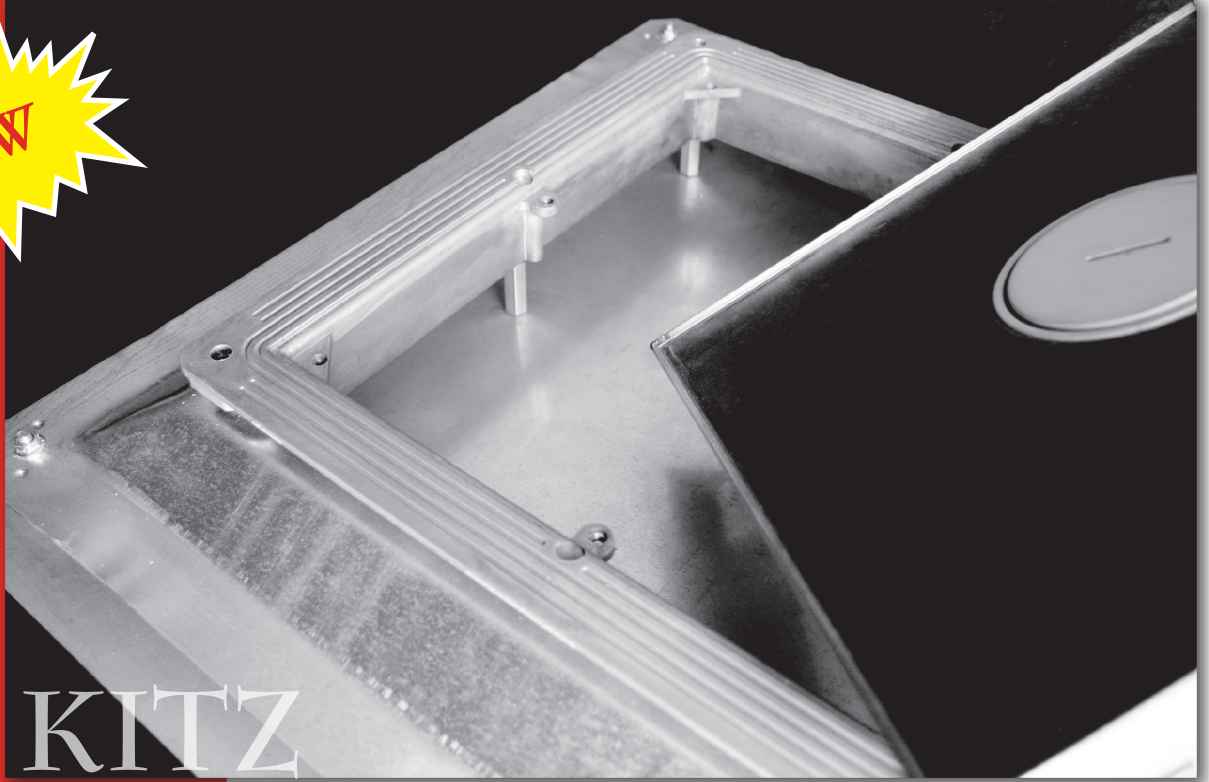

KITZ

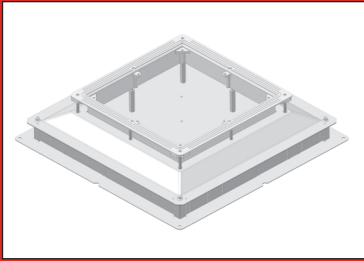

**PANDORA V with KITZ
for heavy loads**

KIT for PANDORA V floor box for heavy loads

Thanks to this heavy-duty kit, you can increase the load capacity of the floor box, considerably. The kit is used in showrooms, garages or places where the floorbox may be subject to heavy loads up to a maximum of two tonnes.

The KITZ kit must be ordered separately and consists of eight VM6 nuts and four 6*60 screws.

cover ITKV 23*257, ITKVWD 23*257 and IKDV 26*257

If a floor box for heavy loads is required, these three covers can be fitted with a metal plate 6 mm thick. Both metal plate of the blind cover ITKV 23*257 Z 6 and the metal plate of the waterproof tile cassette ITKVWD 23*257 Z 6 and the metal plate of the stainless steel hinged cover IKDV 26*257 Z 6 are only available on request.

Availability: stock



For further info: export@vergokan.com

KITZ

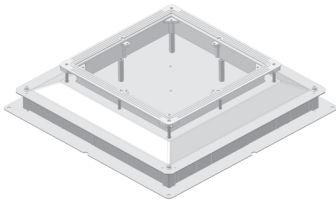



Kit for PANDORA heavy loads

art.-réf.				
KITZ	v	0,27	1	Per set of eight VM 6 nuts and four 6*60 screws.

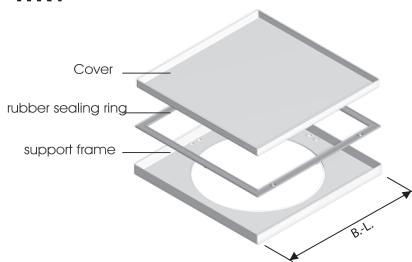
ITKV





Tile frame

B.-L.	art.-réf.				
258mm	ITKV 13*257	v	1,50	1	
258mm	ITKV 23*257	v	1,73	1	
258mm	ITKV 23*257 Z 6		1,83	1	Metal plate for heavy loads

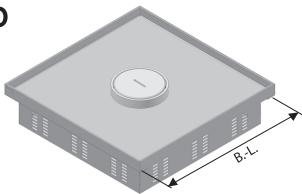
ITKVWD





Tile frame

B.-L.	art.-réf.				
258mm	ITKVWD 13*257	v	1,38	1	
258mm	ITKVWD 23*257 Z 6		1,83	1	Metal plate for heavy loads

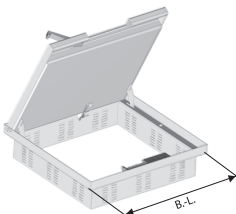
IKDV



Hinged cover

B.-L.	art.-réf.				
258mm	IKDV 16*257	v	1,50	1	
258mm	IKDV 26*257	v	1,73	1	
258mm	IKDV 26*257 Z 6		1,67	1	Metal plate for heavy loads

WIRE CABLE TRAY

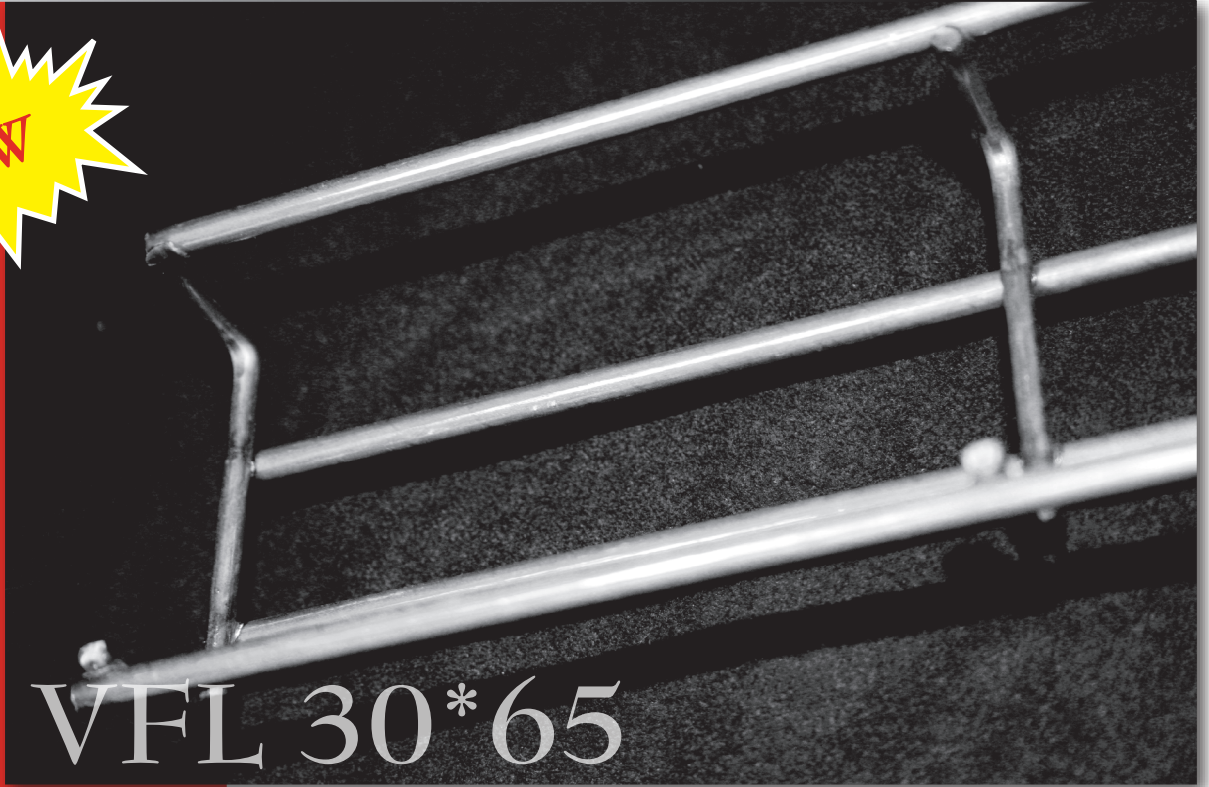

VFL 30*65

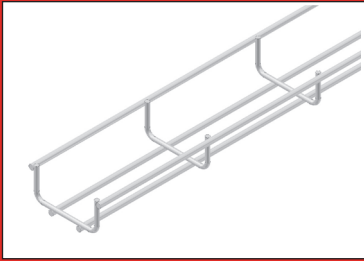

VFL 30*65: wire cable tray

Wire cable tray VFL 30*65

With the introduction of the VFL 30*65, the VFL 35*050 disappears from our range. This product can only be connected with the VFK clip and is 3000mm long.

Material

Electro zinc plated
On request hot-dip/epoxy

Availability: stock



For further info: export@vergokan.com

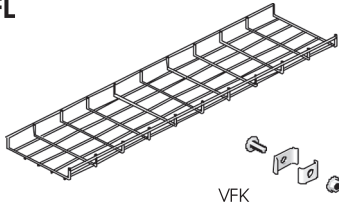

VFL



Screen: 50x100mm

Cross-wire : \varnothing 3,50mmAlongside wire: \varnothing 5,00mm

Wire cable tray light duty

B.-L.	art.-réf.			
60mm	VFL 30*065		0,58	60
95mm	VFL 35*100		0,60	60
146mm	VFL 35*150		0,79	60
196mm	VFL 35*200		0,96	60
245mm	VFL 35*250		1,12	60
345mm	VFL 35*350		1,45	60
445mm	VFL 35*450		1,78	60
545mm	VFL 35*550		2,11	60
	VFK	v	0,02	100

SNAP QUICK-JOINT PLATE

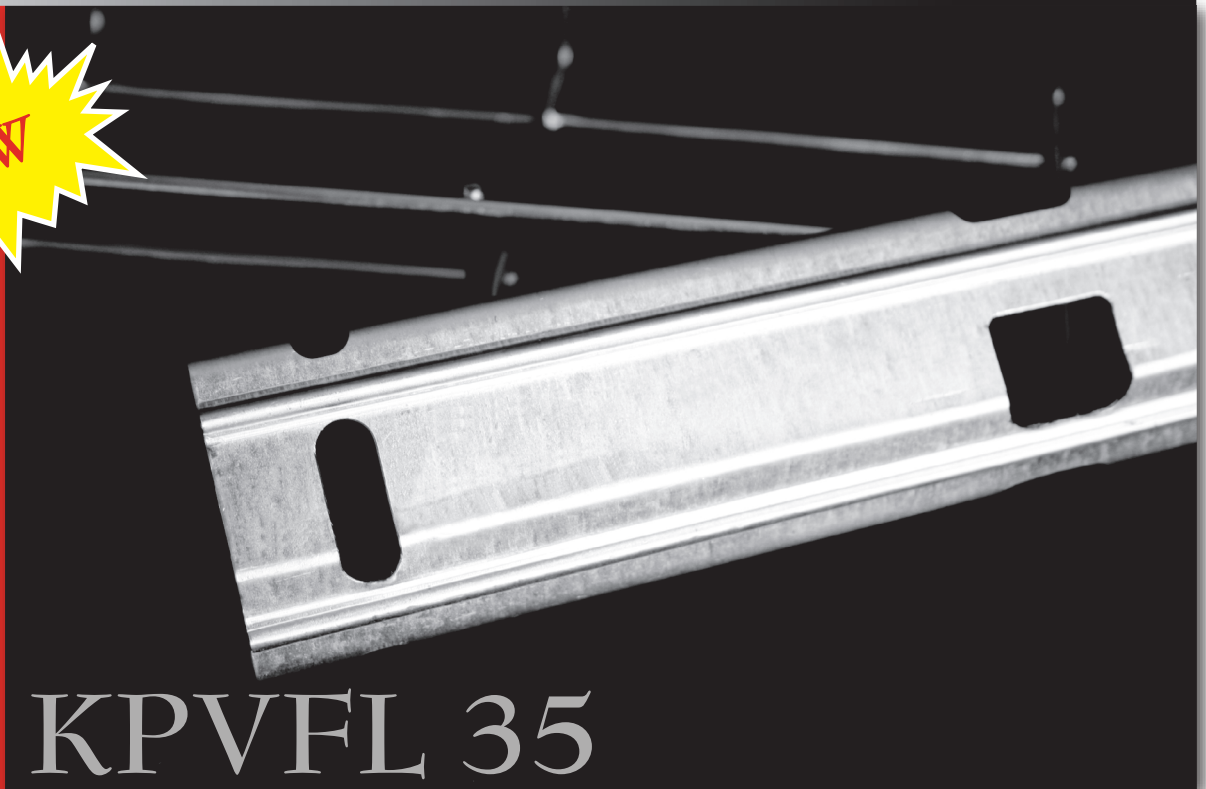

KPVFL 35

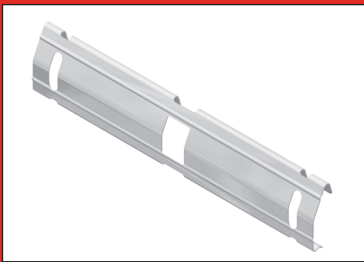

KPVFL 35: quick-joint plate



Snap quick-joint plate KPVFL

The tremendous success of the KPVF 60 has motivated to design a similar concept for the VFL 35 range: the KPVFL 35. With this extension to the range, fast assembly of the VFL 35 basket tray can also be fitted without nuts and bolts

Material

Sendzimir

On request hot-dip/epoxy

Availability: July 2005



For further info: export@vergokan.com

KPVFL 35

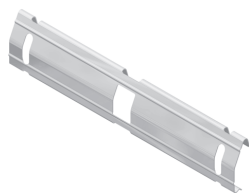

Snap quick-joint plate

art.-réf.



KPVFL 35

v

0,10

30

BOLT CUTTER for WIRE CABLE TRAYS

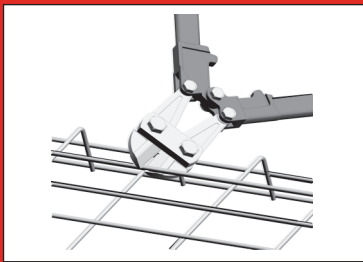
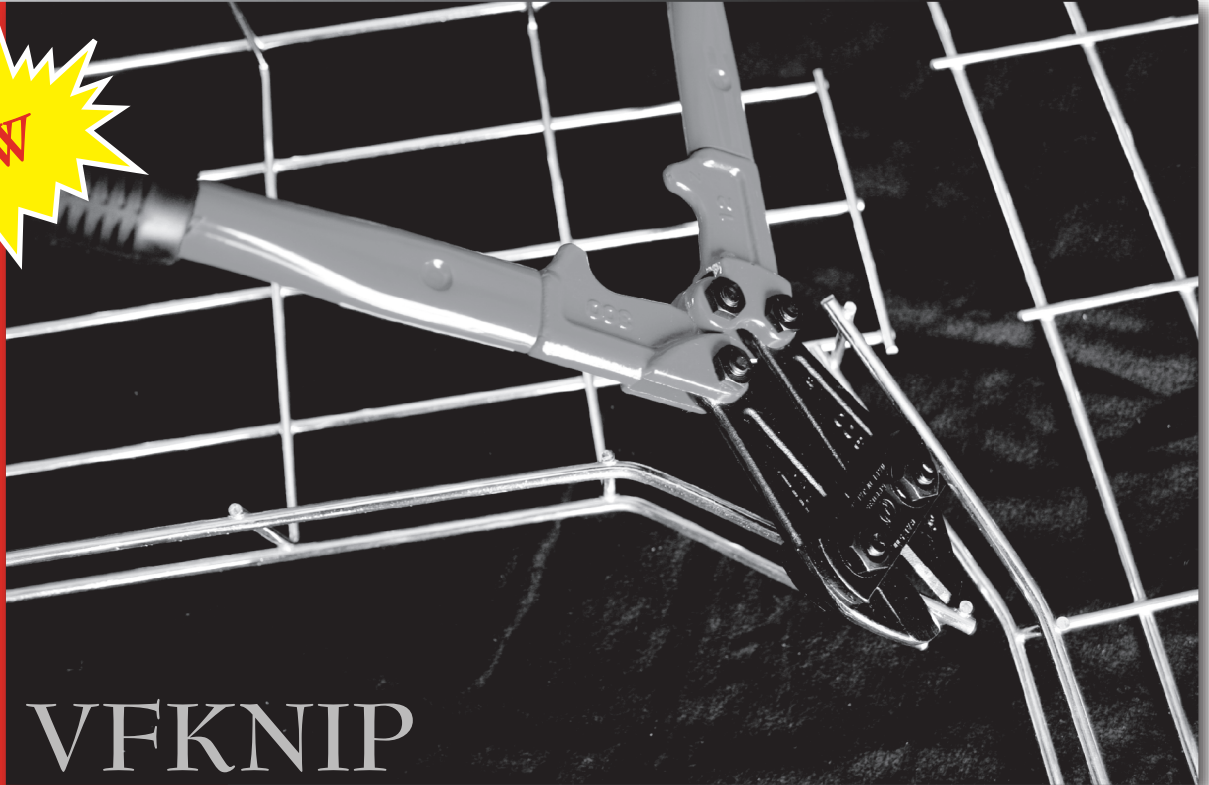

VFKNIP: bolt cutter

Bolt cutter VFKNIP for cutting wire cable trays

By means of a simple cut wire cable trays can be converted into bend, T-piece, crosspiece or reducer. In response to market demand, the bolt cutter with offset cut was included as standard in the range. Cutting always occurs as close as possible to the junction of the steel wires, to avoid damage to the cables.

Availability: stock

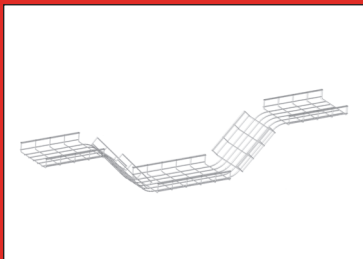

For further info: export@vergokan.com

VFKNIP

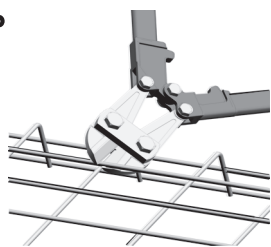

Bolt cutter

art.-réf.



VFKNIP

v

0,75

1

SNAP SUSPENSION BRACKET

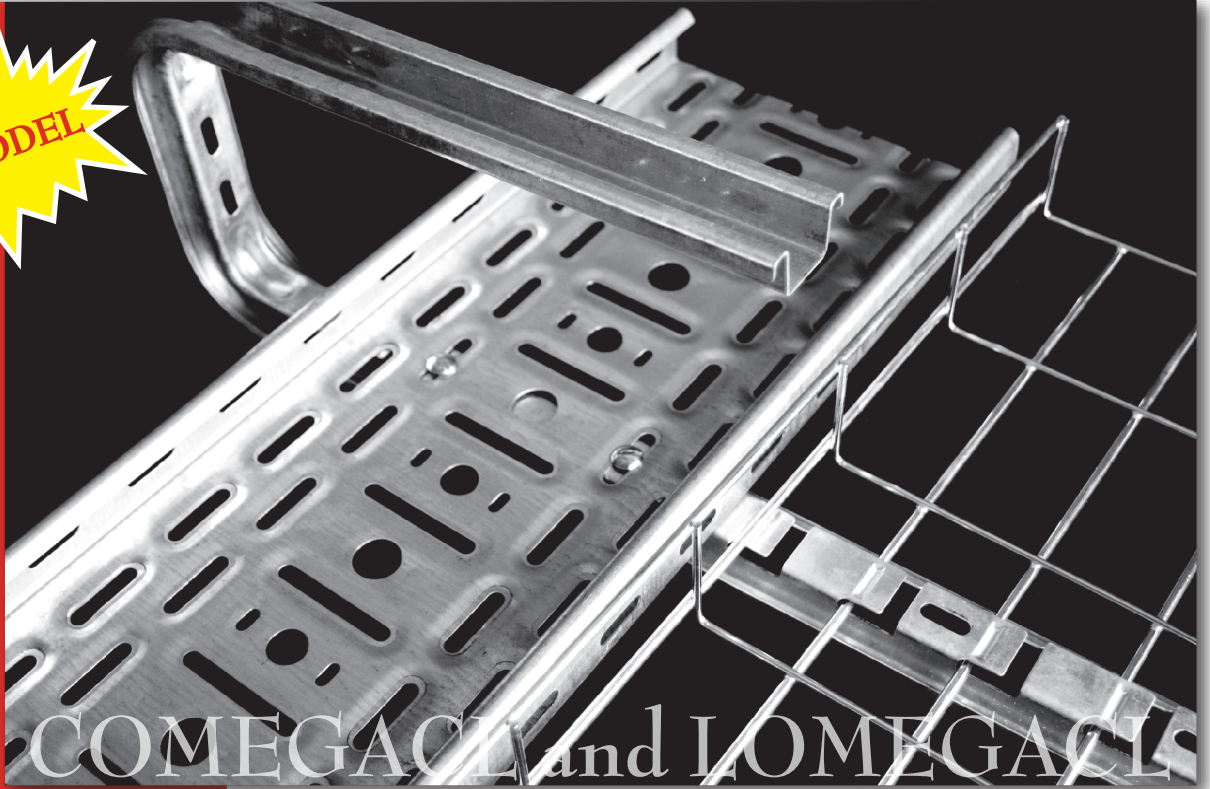

COMEGACL and LOMEGACL



COMEGACL

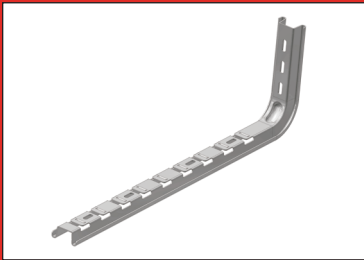

LOMEGACL

COMEGACL and LOMEGACL

Thanks to the snap version of the bracket clips, installation of the basket trays can be carried out quickly and efficiently. Due to the constant quest for product improvements, we have been able to make our COMEGACL and LOMEGACL universal.

The clippable ceiling profiles are now fitted as standard with slit holes, which makes it possible to use both basket trays and cable trays. Thanks to the standard height of 170 mm, these new ceiling profiles can also be installed without any problem in low double or false ceilings.

Material
Sendzimir



Availability: August 2005



For further info: export@vergokan.com



COMEGACL

Suspension bracket clips

B.-L.	art.-réf.			
100mm	COMEGACL 170*100	v	0,36	6
200mm	COMEGACL 170*200	v	0,40	6
300mm	COMEGACL 170*300	v	0,54	6
400mm	COMEGACL 170*400	v	0,78	6
500mm	COMEGACL 170*500	v	0,95	6

LOMEGACL

Bracket clips

B.-L.	art.-réf.			
100mm	LOMEGACL 170*100	v	0,26	6
200mm	LOMEGACL 170*200	v	0,30	6
300mm	LOMEGACL 170*300	v	0,37	6
400mm	LOMEGACL 170*400	v	0,54	6
500mm	LOMEGACL 170*500	v	0,66	6

INNOVATIVE SNAP CEILING PROFILE

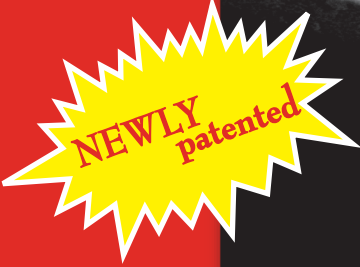

KPCL and MPCL

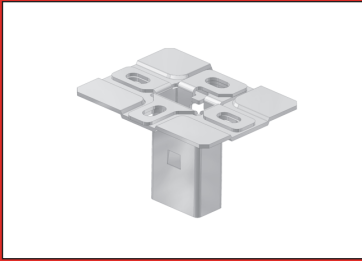

KPCL: headplates



MPCL: profile

KPCL 41*21 and MPCL 41*21



The HSLECL is now also available in 2 separate clippable parts. This change has the major advantage that the brackets can be pre-fitted onto the profile and the headplates can easily be fitted into the ceiling.

Assembling the whole unit in this way is particularly easy.

Pay attention: The end plate should always be fixed with the supplied supporting plate STP. This system is revolutionary and extremely cost effective.

Moment for screw M10 with quality 8.8 : 133 Nm.

Tested according to: CEI/IEC 61537.

The MPCL 41*21 profile is available in length:

200-300-400-500-600-800-3000

Material
Sendzimir

Availability: september 2005

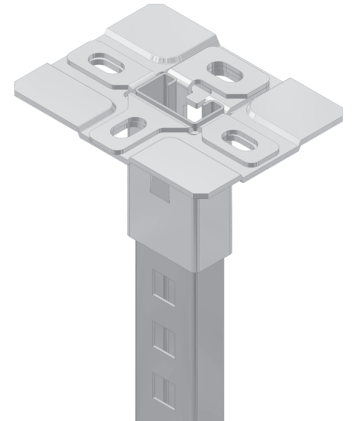

For further info: export@vergokan.com

KPCL 41*21

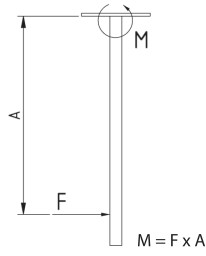
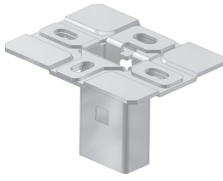

Headplates

art.-réf.

KPCL 41*21



v



0,28



10

MPCL 41*21



Profile

art.-réf.

MPCL 41*21*200
 MPCL 41*21*300
 MPCL 41*21*400
 MPCL 41*21*500
 MPCL 41*21*600
 MPCL 41*21*800
 MPCL 41*21*3000



v



0,24
 0,34
 0,48
 0,58
 0,68
 0,92
 3,42



10
 10
 10
 10
 10
 10
 10

ASSEMBLY PROFILES

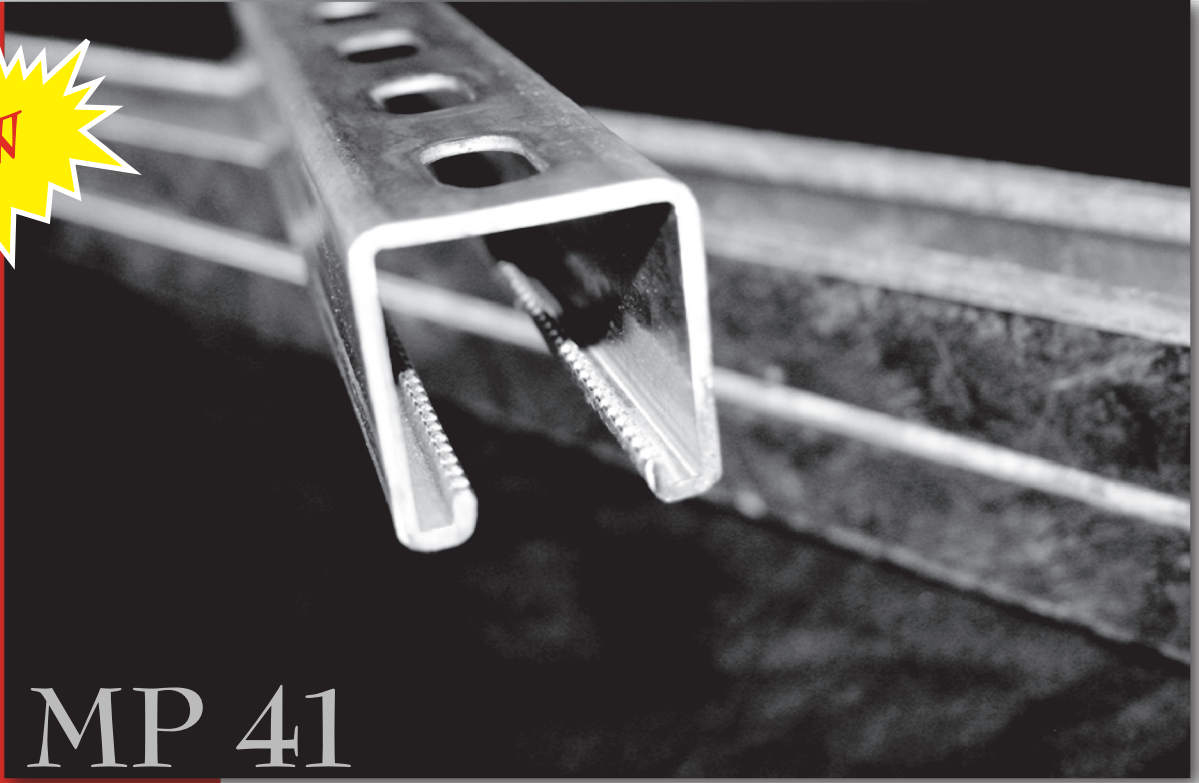

MP 41

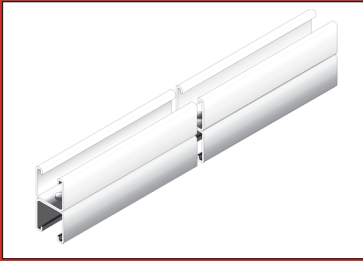

MPZ 41*41 DGL

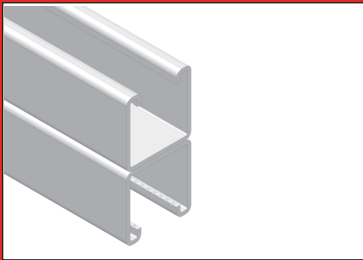

MPZ 41*41 DGL



The double assembly profile, which is available in hot-dip as standard, is now also available in the low-cost Sendzimir finish. Available in length 6000mm

Availability: stock

MP 41*41

All assembly profiles are fitted with serrations, which provides improved frictional resistance. Due to this improving fixing of the sliding nut, installation is made easier.

Availability: stock

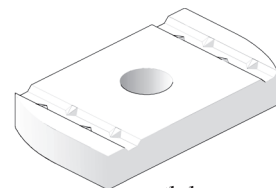

Sliding nut GM 41



For further info: export@vergokan.com

MPZ 41*41 DGL



Montageprofiel dubbel

art.-réf.



MPZ 41 *41 DGL

v

5,70

6

SNAP INSIDE and OUTSIDE RISERS

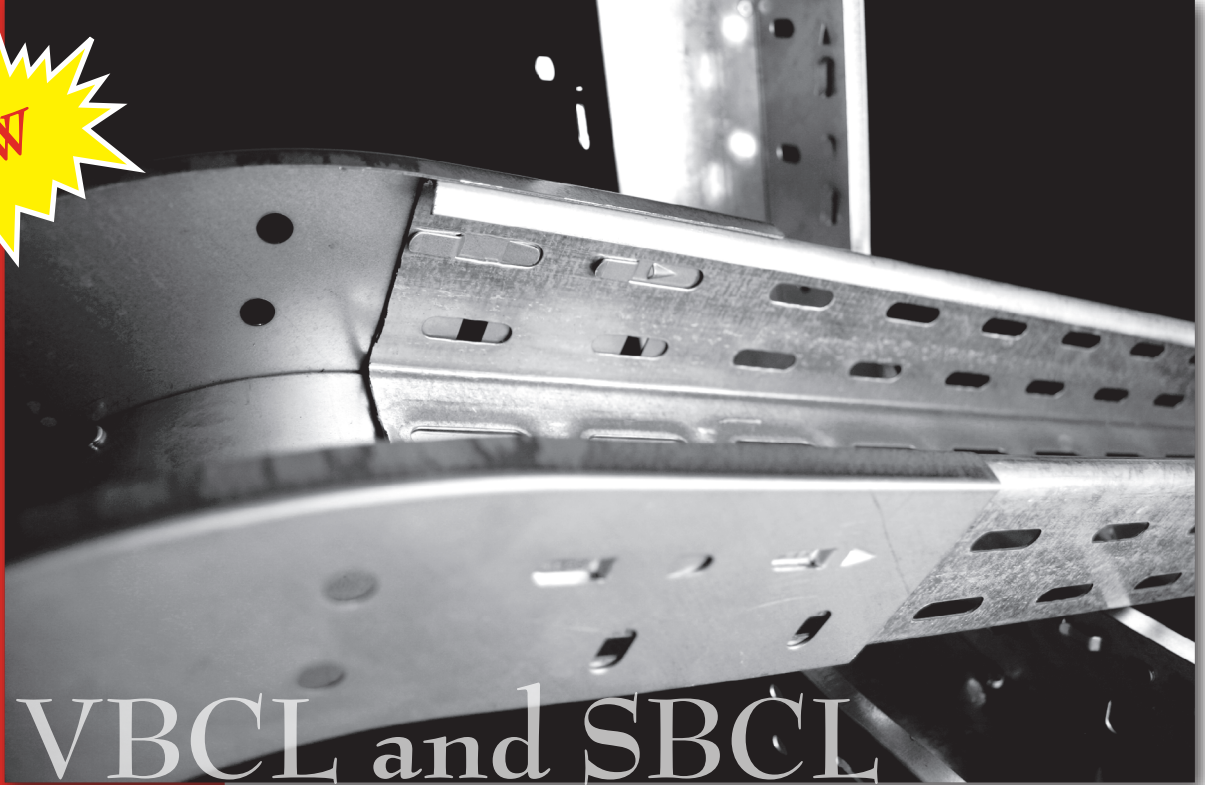

VBCL: outside riser



SBCL: inside riser

Outside riser VBCL and inside riser SBCL



In future, the inside and outside risers will be available in a snap version. By doing this, Vergokan is living up to its reputation as a trendsetter in quick-joint systems. A one way click-system.

The VBCL and SBCL are available in:

Height 60
Width: 050 - 600

Material
Sendzimir



Availability: stock

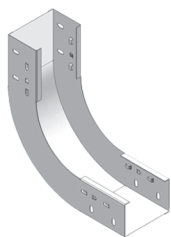

For further info: export@vergokan.com



SBCL

Inside riser

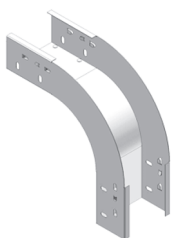
B.-L.	art.-réf.			
50mm	SBCL 90*60*050	v	0,55	1
75mm	SBCL 90*60*075	v	0,65	1
100mm	SBCL 90*60*100	v	0,73	1
150mm	SBCL 90*60*150	v	0,88	1
200mm	SBCL 90*60*200	v	1,00	1
250mm	SBCL 90*60*250	v	1,08	1
300mm	SBCL 90*60*300	v	1,18	1
400mm	SBCL 90*60*400	v	1,43	1
500mm	SBCL 90*60*500	v	1,90	1
600mm	SBCL 90*60*600	v	2,15	1

VBCL

Outside riser

B.-L.	art.-réf.			
50mm	VBCL 90*60*050	v	0,55	1
75mm	VBCL 90*60*075	v	0,63	1
100mm	VBCL 90*60*100	v	0,65	1
150mm	VBCL 90*60*150	v	0,78	1
200mm	VBCL 90*60*200	v	0,85	1
250mm	VBCL 90*60*250	v	0,95	1
300mm	VBCL 90*60*300	v	1,08	1
400mm	VBCL 90*60*400	v	1,33	1
500mm	VBCL 90*60*500	v	1,43	1
600mm	VBCL 90*60*600	v	1,60	1